

## HYDRAULIC RELEIF VALVES

“RL”

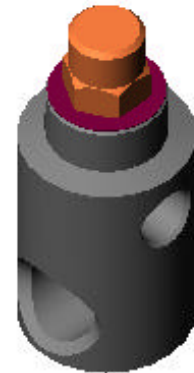

RL75

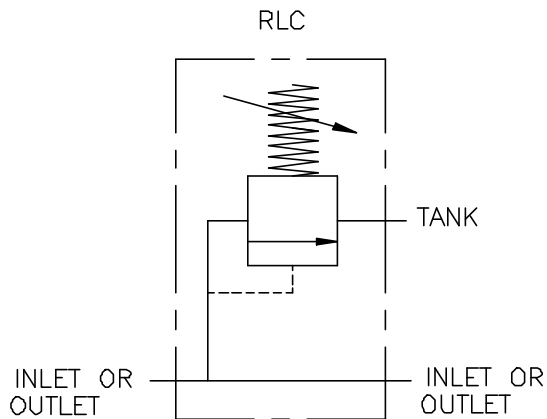
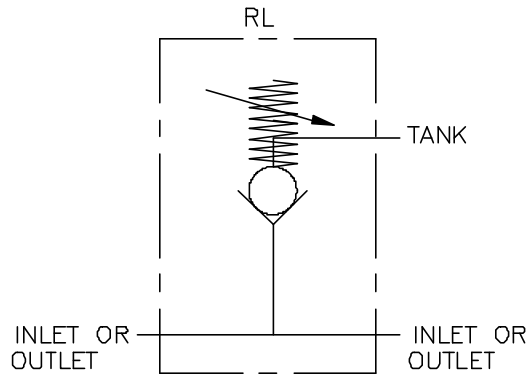
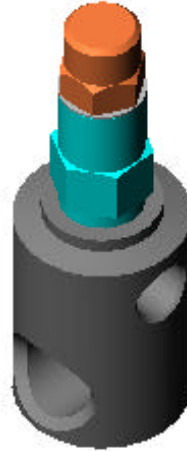

RLC75

RLC16

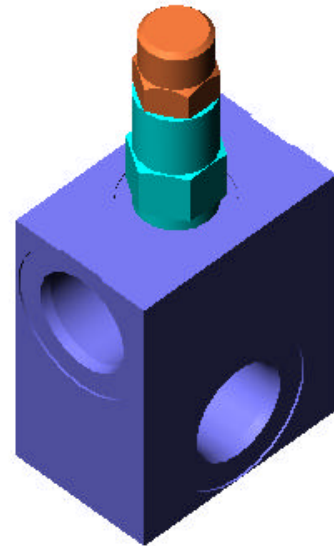

### FEATURES:

- **OPTIONAL HIGH LIFT BALL SPRING RELIEF** reduces noise, heat and chatter.
- **OPTIONAL O-RING PORTS** to eliminate leakage.
- **STEEL BALL** will not jam, lock or seize and will always open.
- **CHROME ALLOY STEEL BALL** is a grade No. 25 ball.
- **HARDENED ALLOY STEEL SEAT** to reduce wear.
- **SHOT PEENED STRESS RELIEVED** steel spring to increase life and consistent results.

### SPECIFICATIONS:

- **Pressure rating 3000 psi (207 bar).**
- **Pressure setting 150-3000 psi (10-207 bar).**
- **See creating a model code for flow capacity.**
- **Weighs 2 1/4 lbs (1.0 kg).**

### MATERIALS:

- **Zinc Plated Steel Body**
- **Chrome Alloy Steel Ball**
- **Hardened Alloy Steel Seat**

**RL – GENERAL INFORMATION:**

The Brand, relief valve is precision built, dependable and low priced. Both the RL and RLC are of the ball spring type, which is the most dependable type of relief valve. The ball will not jam, lock, or seize and will always open. The advantage of the RLC over the RL option is that cracking pressure at low and high flow is virtually the same. The RLC is also more stable when flow is traveling past the ball and spring. (See relief flow charts below)

**RL – EXAMPLES OF COMMON MODEL CODES:**

- RL10-1500**.....Ball spring relief, all ports are #10SAE and the relief is set at 1500 psi.
- RL50-1500**.....Ball spring relief, all ports are 1/2” NPT and the relief is set at 1500 psi.
- RL75-2000**.....Ball spring relief, tank port is 1/2” NPT, pressure ports are 3/4” NPT and the relief is set at 2000 psi.
- RLC75-3000**.....High lift ball spring relief, tank port is 1/2” NPT, pressure ports are 3/4” NPT and the relief is set at 3000 psi.
- RLC16-1500**.....High lift ball spring relief, rated for 30 gpm, #16SAE all ports, manifold body and the relief is set at 1500 psi.

**RL – CREATING A MODEL CODE FOR RL’S:**

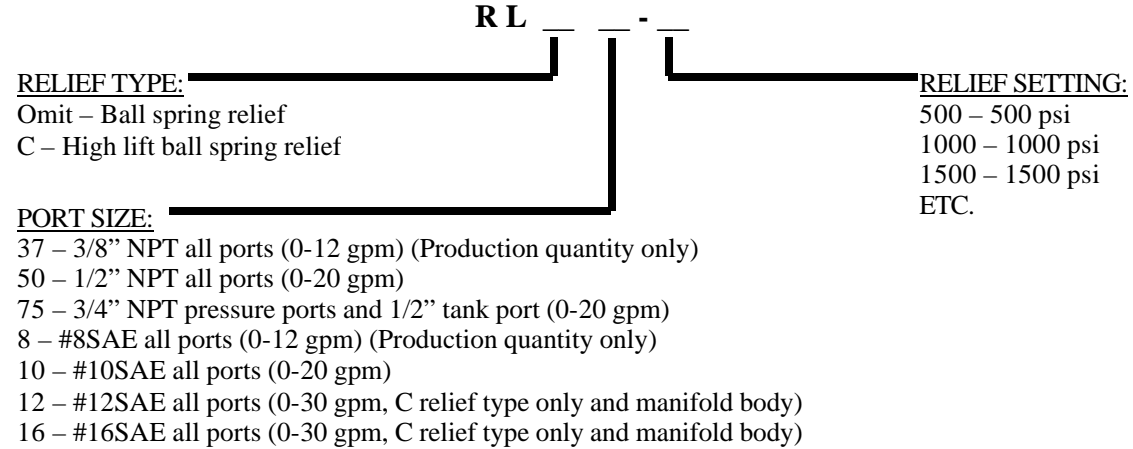

**RL FLOW AND PRESSURE INFO**

**Pressure vs. Flow for RL**

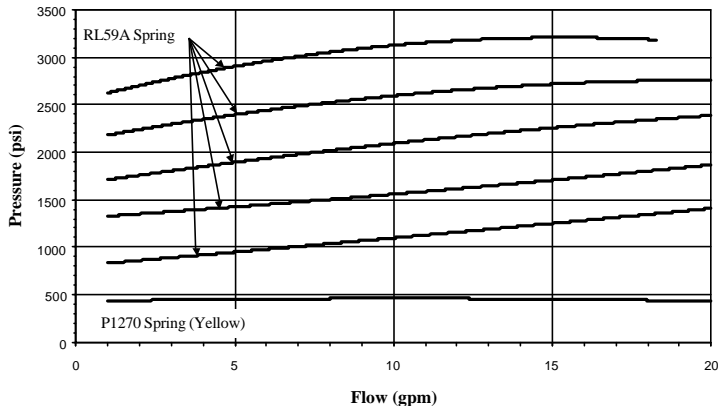

**Pressure vs. Flow for RLC (0-20 gpm)**

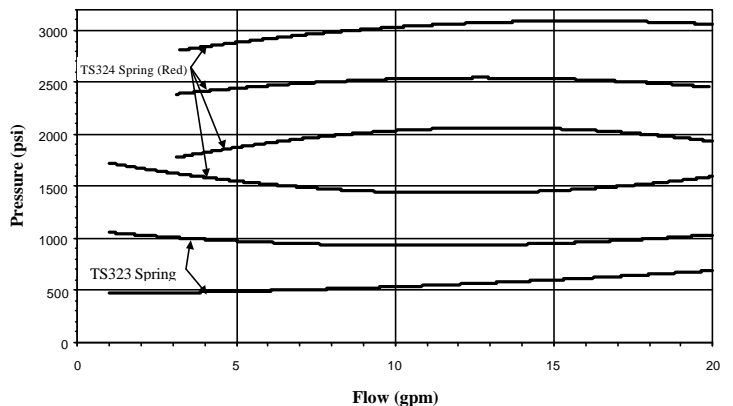

### RL FLOW AND PRESSURE CONT...

Pressure vs. Flow for RLC (0-30 gpm)

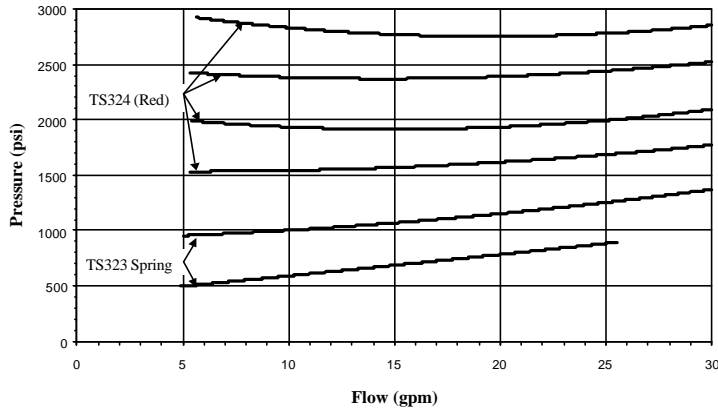

### DIMENSIONAL DATA:

