

4 – WAY PRESSURE COMPENSATED FLOW CONTROL “SDCF”

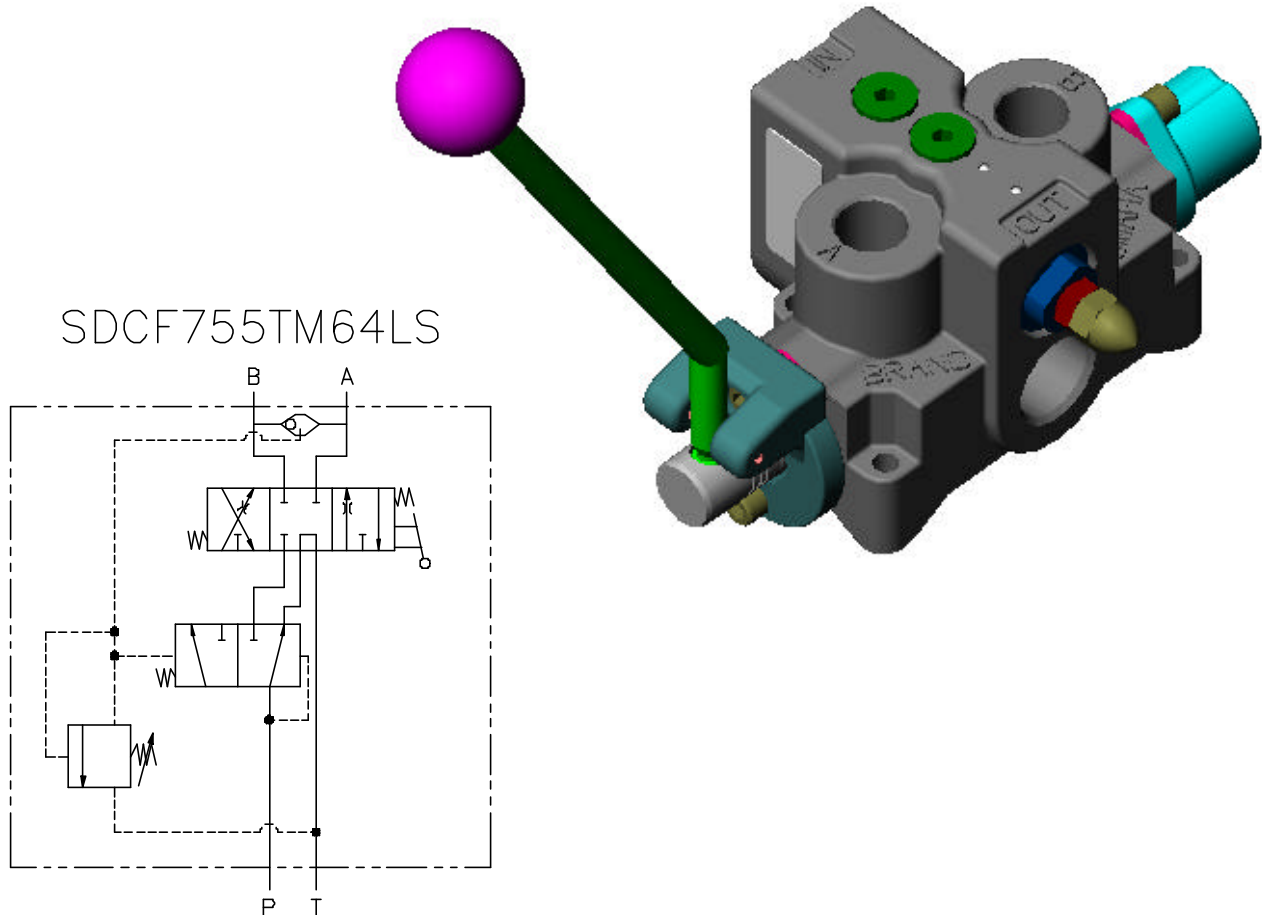

FEATURES:

- **PILOT OPERATED RELIEF VALVE** is standard on every SDCF.
- **FULL RANGE PRESSURE COMPENSATED** by-pass type flow control valve built in.
- **SDCF REDUCES** the number of fittings, plumbing and potential leaks in hydraulic circuits.
- **FINE POSITIVE METERING** in either direction with the manual handle.
- **PRECISION GROUND CHROME PLATED SPOOL** that assures long life.
- **OPTIONAL O’RING PORTS** to eliminate leakage.

SPECIFICATIONS:

- **Rated for 0-18 gpm (0-68.1 lpm).**
- **Rated for 3000 psi (207 bar).**
- **Weights 6-1/2 lbs. (2.9 kg).**
- **30 – Micron filtration recommended.**

MATERIALS:

- **Cast Iron Body**
- **Buna N O’Rings**
- **Chrome Plated Steel Spool**
- **Consult Factory for Stainless Steel Spools**

SDCF – GENERAL INFORMATION:

The Brand, SDCF combines the features of a four-way directional control valve, a full range pressure compensated by-pass type flow control valve, and a pilot operated pressure relief valve all in one compact package. This valve reduces the number of fittings, plumbing and potential leakage points in hydraulic circuits. The manual handle allows the customer to meter the flow out of either port. Flow to the work port is directly proportional to the movement of the lever. Flow out of each work port is constant regardless of load changes, this allows the customer to maintain smooth and constant movement of a cylinder or motor. Every SDCF comes standard with a pilot operated relief. The tank port must be plumbed directly back to tank.

SPOOL TYPE – The spool types we offer are tandem center (T), open center (O), open meter center (OM), fine metering (M), and tandem metering (TM). (See chart on next page and schematics on page #4 for information on spool types)

ACTUATORS – Lever handle (L) pressurizes the B port when the handle is pushed towards the valve body. Lever handle (J) pressurizes A port when the handle is pushed towards the valve body. Rotary handle (H) is used to rotate spool in or out of valve body. No actuator (N) L type spool. No actuator (M) J type spool.

SPOOL ACTION – Three-position detent (D) holds the spool in neutral and both active positions. Friction detent (F1) applies friction to the spool so that the spool does not move when the handle is released either side of neutral, a detent groove clearly indicates neutral position. Spring center (S) returns the handle to neutral when the handle is released. Spring center detent (SD) springs back to neutral from one position and is mechanically detented in the other position (flow out port A in detent). Spring offset (SO) spring holds spool in one active position (flow out port B). Rotary friction detent (E) applies friction to the spool as it is rotated so that the spool does not rotate when the handle is released either side of neutral, a detent groove clearly indicates neutral position. Two-position detent (2D) P to B only. Two-position detent (D2) P to A only. Normally closed electric switch (WC) used with (S), (F1) and (D) options only. Normally open electric switch (WO) used with (S), (F1) and (D) options only.

SDCF – EXAMPLES OF COMMON MODEL CODES:

SDCF755TM64LF1.....3/4" inlet and outlet ports, 1/2" work ports, 0-6 gpm tandem metering spool, L style handle and neutral position friction detent.

SDCF120TM184LF1.....#12SAE inlet and outlet ports, #10SAE work ports, 0-18 gpm tandem metering spool, L style handle and neutral position friction detent.

SDCF755TM124LS.....3/4" inlet and outlet ports, 1/2" work ports, 0-12 gpm tandem metering spool, L style handle and neutral position spring center.

SDCF – COMPLETE LIST OF OPTIONS AND ACCESSORIES:

SDC-D..... Three-position detent kit.

SDC-WC..... Three-position detent kit with normally closed electric switch.

SDC-WO..... Three position detent kit with normally open electric switch.

SDC-F1..... Ball friction detent.

SDC-F1WC..... Ball friction detent with normally closed electric switch.

SDC-F1WO..... Ball friction detent with normally open electric switch.

SDC-HJ..... J style handle kit.

SDC-HL..... L style handle kit.

SDC-S..... Spring centering kit.

SDC-SD..... Spring center detent kit (P to A in detent).

SDCF – COMPLETE LIST OF OPTIONS AND ACCESSORIES CONT...

- SDC-SO.....Spring offset kit (P to B).
- SDC-SOHD.....Heavy duty spring offset kit (P to B).
- SDCF-K.....Seal kit for SDCF.

SDCF – CREATING A MODEL CODE FOR SDCF'S:

S D C F 4

PORT SIZE:
 755 – 3/4” inlet/outlet and 1/2” work ports
 120 – #12SAE inlet/outlet and #10SAE work ports

SPOOL TYPE:
 T – Tandem Center
 O – Open Center
 OM – Open metering
 M – Fine metering
 TM – Tandem metering

FLOW SETTING:
 Omit – When using T and O spool
 6 – 0-6 gpm (OM, M and TM only)
 12 – 0-12 gpm (OM, M and TM only)
 18 – 0-18 gpm (OM, M and TM only)

RELIEF OPTION:
 Omit – Standard relief
 NR – No relief

SPOOL ACTION:
 S – Spring center
 D – Three-position detent
 F1 – Friction detent
 WC – Norm. close elec. switch (used with S, D and F1)
 WO – Norm. open elec. switch (used with S, D and F1)
 SO – Spring offset (P to B)
 SD – Spring center / detent (P to A in detent)
 2D – Two-position detent P to B
 D2 – Two-position detent P to A
 E – Rotary friction detent

HANDLE OPTION:
 L – Lever handle (B port is active when handle is pushed)
 J – Lever handle (A port is active when handle is pushed)
 N – No actuator (L type spool)
 M – No actuator (J type spool)
 H – Rotary handle (Used only in conjunction with rotary friction detent)

SDCF – FLOW AND PRESSURE INFO:

Pressure vs. Flow for Pilot Relief
 Relief is set at 6 gpm

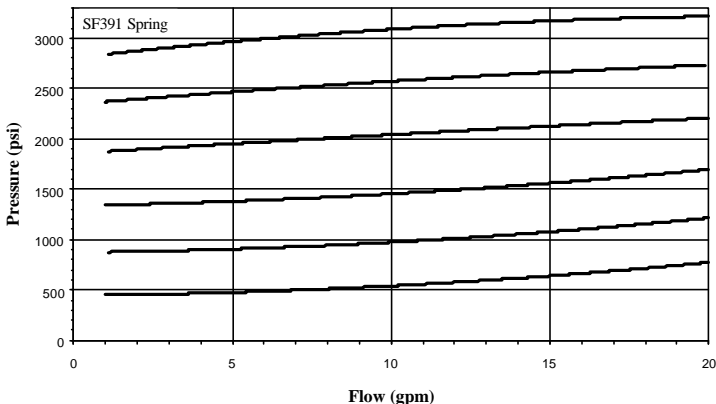

Neutral Flow Pressure Drop

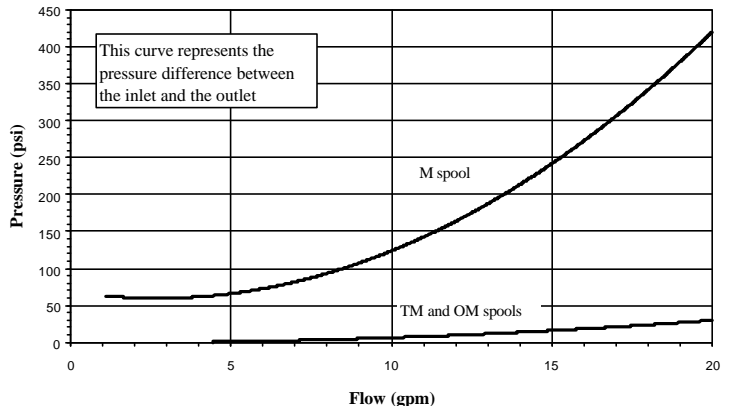

SPOOL SCHEMATICS:

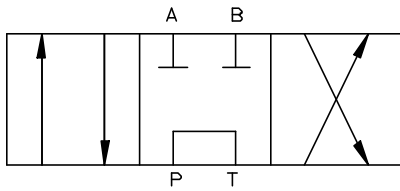

Tandem Center (T) – Powers cylinder or motor in both directions (metering capability is very limited). Pump unloads to tank when spool is in neutral. Cylinder or motor blocked when spool in neutral.

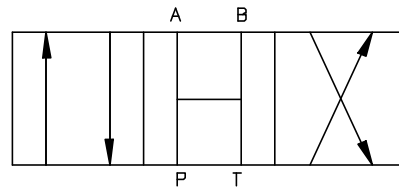

Open Center (O) – All of the ports are connected to tank when the spool is in neutral. Allows cylinder to move or motor to rotate when spool is in neutral.

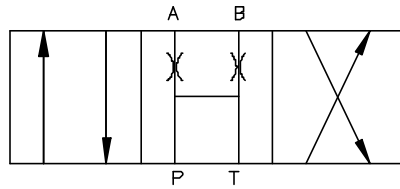

Fine Metering Spool (M) – The pressure drop in neutral is higher than the (OM) and (TM) spools. Requires external locking valves to hold cylinder, because ports A and B are open (orificed) in the neutral position. Extremely fine metering control.

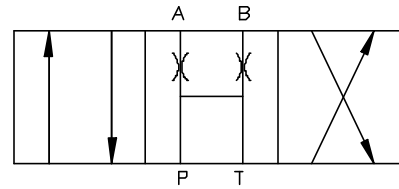

Open Metering Spool (OM) – The neutral pressure drop is much lower than the (M) spool. Extremely fine metering control. Ports A and B are open (orificed) in the neutral position.

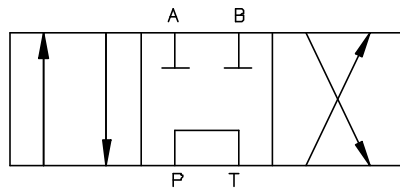

Tandem Metering Spool (TM) – Similar to (T) spool except much finer metering control. The pressure drop in neutral is lower than the (M) spool. Cylinder or motor blocked in neutral and pump unloads to tank.

DIMENSIONAL DATA:

